

## Section 4 – SR-4 Trailer S/T Electronic Engine Operation

---

### Display

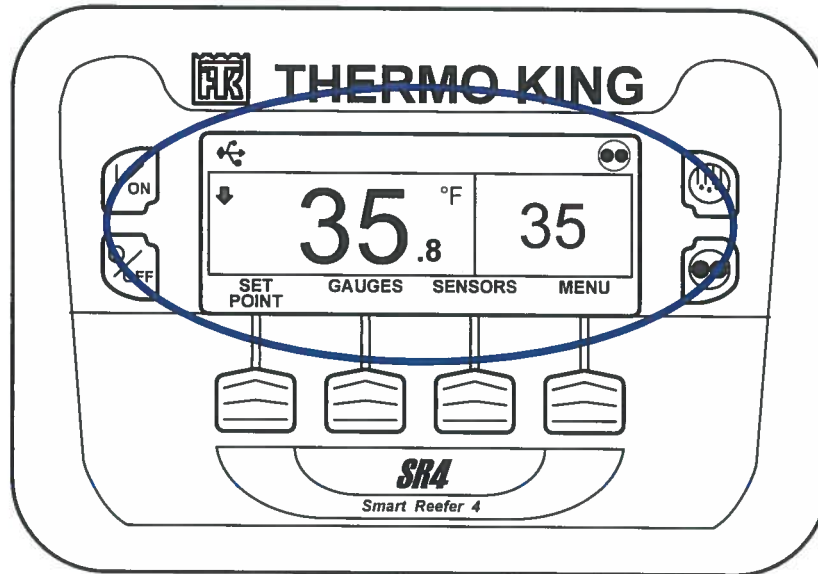

The display is used to present information to the operator. This information includes setpoint and temperature, unit operating information, gauge readings, temperatures, alarm codes and other information as selected by the operator or technician. The Standard Display of box temperature and setpoint is shown above. The unit has a setpoint of 35°F, and an actual box temperature of 35.8°F.

### Display Icons

Display symbols or Icons are used to present additional unit information as shown below.



The down-pointing arrow at the left side of the display shows the unit is cooling. If the arrow were pointing upward the unit would be heating.



The unit is running in Cycle Sentry Mode as shown by the Cycle Sentry Icon in the upper right corner of the display. If the Cycle Sentry icon is not present, the unit is running in Continuous Mode.



The USB Icon in the upper left corner of the display will appear when a USB device is connected to either of the USB Ports on the Unit Control Panel.

## Section 4 – SR-4 Trailer S/T Electronic Engine Operation

---

### Keys

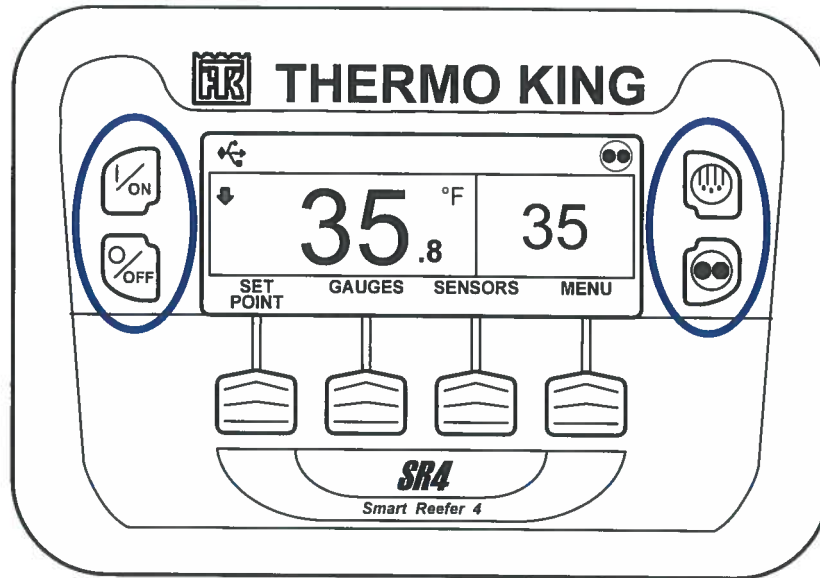

### Hard Keys

The keys on either side of the display are dedicated or "hard" keys. Their function always remains the same.



The ON Hard Key is used to turn the unit on. First the display will briefly show the Thermo King Logo and then the statement "Configuring System – Please Wait". When the power-up sequence is complete the display shows the Standard Display of box temperature and setpoint. For more information see "Turning the Unit On and Off" later in this section.



The OFF Hard Key is used to turn the unit off. First the display will briefly show "System is Powering Down – Please Wait. Press On to Resume" and then "Off" will appear momentarily. When the power-down sequence is complete the display will be blank. For more information see "Turning the Unit On and Off" later in this section.



The DEFROST Hard Key is used to initiate a manual defrost cycle. For more information see "Initiating a Manual Defrost Cycle" later in this section.



The CYCLE SENTRY Hard Key is used to select Cycle Sentry Mode or Continuous Mode operation if allowed by OptiSet Plus. For more information see "Selecting Cycle Sentry or Continuous Mode" later in this section.

## Section 4 – SR-4 Trailer S/T Electronic Engine Operation

---

### Soft Keys

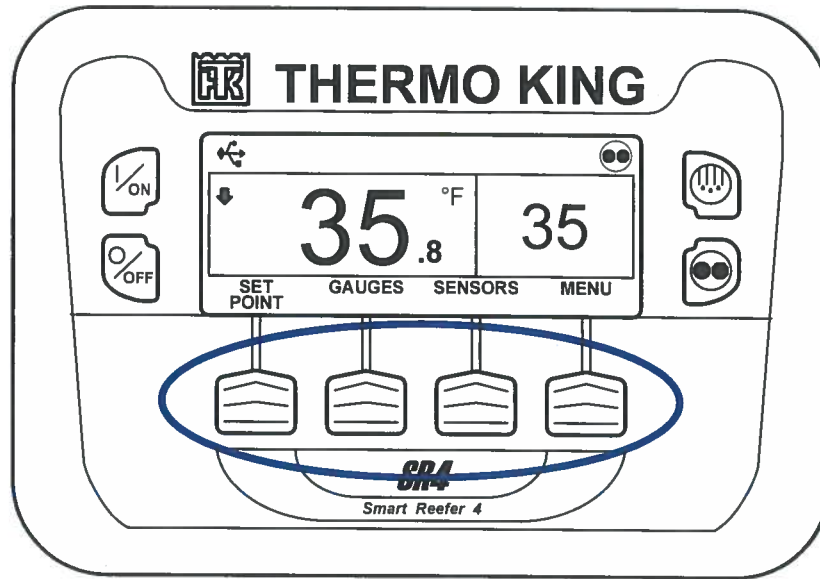

The four "soft" keys under the display are multi-purpose keys. Their function changes depending on the operation being performed. If a soft key is active the key function is shown in the display directly above the key. The keys are numbered from left to right, with Key 1 on the far left and Key 4 on the far right.

**NOTE:** The key function shown in the display will be shown in the language selected. For example, if German is selected as the display language, then all soft key functions in the display will be shown in German.

#### Typical soft key functions:

MENU	
NEXT	BACK
YES	NO
+	-
SELECT	EXIT
CLEAR	HELP
HOUR METERS	SENSORS
GAUGES	

## Section 4 – SR-4 Trailer S/T Electronic Engine Operation

---

### TURNING THE UNIT ON

The unit is turned on by pressing the ON Key and off by pressing the OFF Key. When the On Key is pressed the display briefly shows the THERMO KING Logo as the display initializes.

**IMPORTANT:** The ON Key must be held down until the Thermo King Logo appears. If the ON Key is not held down long enough (approximately ½ second), the display may flicker but the unit will not start up. If this occurs, hold the ON Key down until the Thermo King logo appears.

**NOTE:** *With extremely cold ambient temperatures it may take up to 15 seconds for the display to appear on initial startup.*

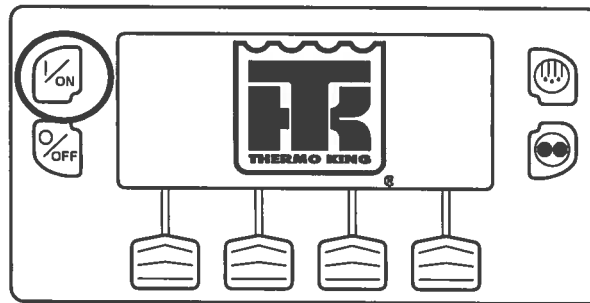

Then the startup screen shown below appears while communications are established and the unit prepares for operation.

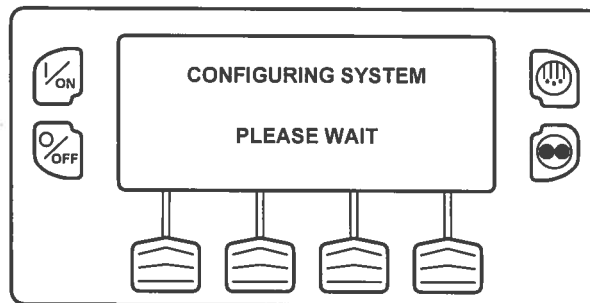

## Section 4 – SR-4 Trailer S/T Electronic Engine Operation

---

### TURNING THE UNIT OFF

Pressing the OFF Key stops unit operation. The unit shuts down immediately and the display briefly shows the power down message.

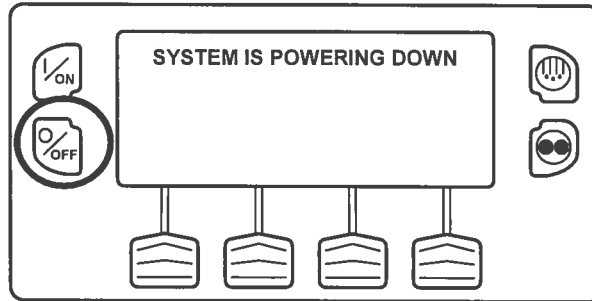

The display briefly shows OFF and then goes blank. To start the unit again, press the ON Key.

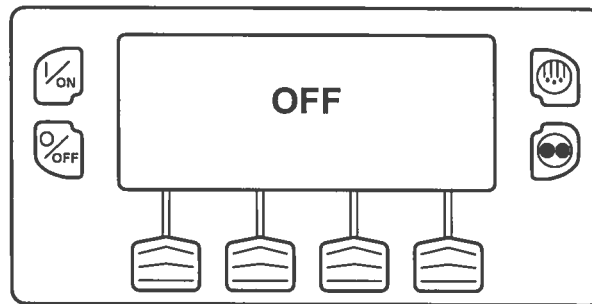

## Section 4 – SR-4 Trailer S/T Electronic Engine Operation

---

### THE STANDARD DISPLAY

The Standard Display is the default display that appears if no other display function is selected. The Standard Display shows the box temperature and setpoint. The box temperature is that measured by the controlling sensor, usually the return air sensor. The box temperature here is 35.8°F with a 35°F setpoint.

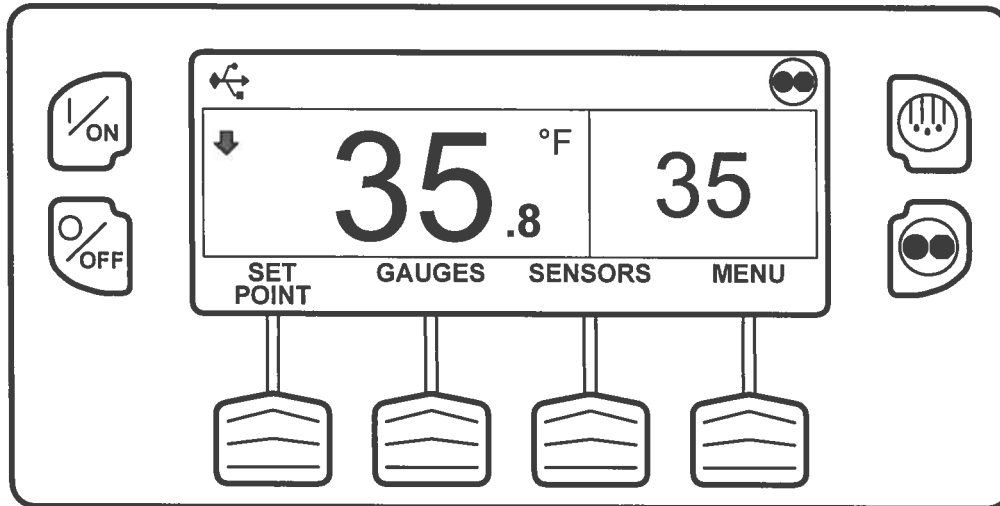

The down-pointing arrow at the left side of the display shows the unit is cooling. If the arrow were pointing upward the unit would be heating.



The unit is running in Cycle Sentry Mode as shown by the Cycle Sentry Icon in the upper right corner of the display. If the Cycle Sentry icon is not present, the unit would be running in Continuous Mode.



The USB Icon in the upper left corner of the display will appear when a USB Flash Drive is connected to the Flash Drive Only USB Port or a PC computer is connected to the PC Only USB Port on the Unit Control Panel.

Pressing the left soft key allows the user to change the SETPOINT, and pressing the right soft key accesses the MAIN MENU. The other two soft keys access the GAUGES menu and the SENSORS menu.

**NOTE:** The functions of the GAUGES and SENSORS soft keys may be re-assigned to better suit customer requirements. The GAUGES and SENSORS functions are always available from the Maintenance Menu.

## Section 4 – SR-4 Trailer S/T Electronic Engine Operation

---

### THE TEMPERATURE WATCH DISPLAY

The TemperatureWatch Display appears 2 ½ minutes after the Standard Display appears so long as there is no key activity and no check, prevent or shutdown alarms are present. The TemperatureWatch Display will remain on until any key is pressed or a check, prevent or shutdown alarm occurs.

The TemperatureWatch Display shows the box temperature and setpoint. The large numbers allow unit conditions to be checked from a distance. The box temperature is that measured by the controlling sensor, usually the return air sensor. The box temperature here is 35.8°F with a 35°F setpoint. The Cycle Sentry icon in the upper right corner of the display shows that the unit is operating in Cycle Sentry mode. If the Cycle Sentry icon is not present, the unit is running in Continuous Mode. The down-pointing arrow indicates that the unit is cooling. Pressing any soft key returns the display to the Standard Display. The USB Icon next to the Cycle Sentry Icon in the upper right corner of the display indicates that a USB Flash Drive is inserted in the USB Port on the Unit Control Panel.

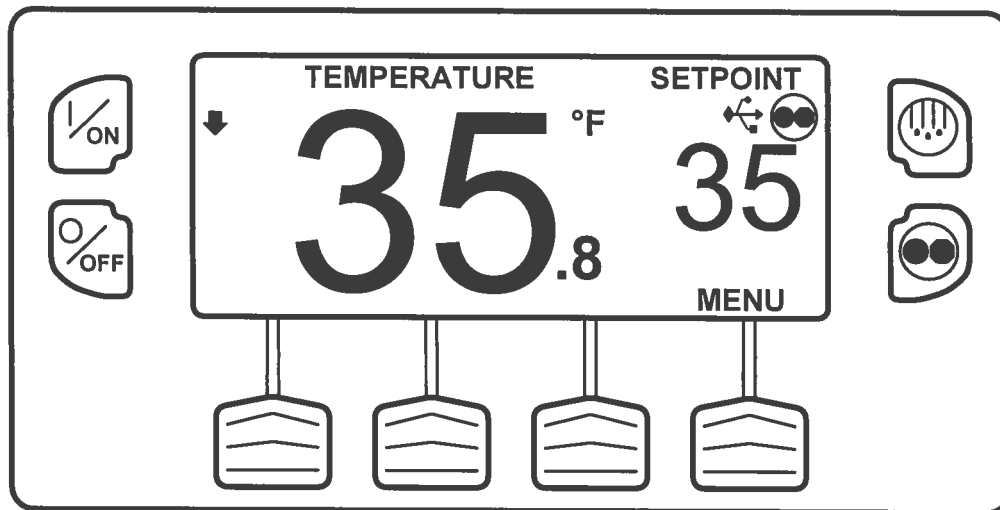

If an alarm condition (other than a log alarm) is present, the TemperatureWatch Display will not appear. If an alarm condition occurs while the TemperatureWatch Display is present the display will return to the Standard Display to indicate that an alarm condition has occurred.

If the Defrost Key or Cycle Sentry Key is pressed, the display will return to the TemperatureWatch Display immediately after the defrost cycle is initiated or the operating mode is changed.

## Section 4 – SR-4 Trailer S/T Electronic Engine Operation

---

### CHANGING THE SETPOINT

The Setpoint is changed from the Standard Display. If the TemperatureWatch display is present, press any key to return to the Standard Display.

**IMPORTANT:** If OptiSet Plus is in use there are several possible options when changing the setpoint.

#### Numerical Setpoints

If OptiSet Plus is not in use or if only Numerical Setpoints are enabled the left soft key will be labeled SETPOINT as shown below.

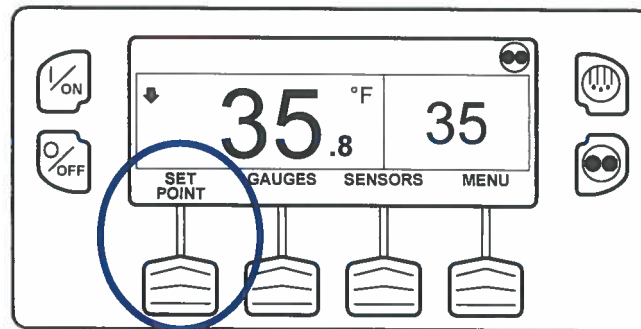

#### Named Products – OptiSet Plus

OptiSet Plus allows the use of Named Products such as APPLES or BANANAS in place of a numerical setpoint. If only named products are enabled the left soft key will be labeled PRODUCT as shown below.

- ✓ A single setpoint temperature may be allowed for the specific named product.
- ✓ A numerical setpoint range may be allowed for the specific named product.

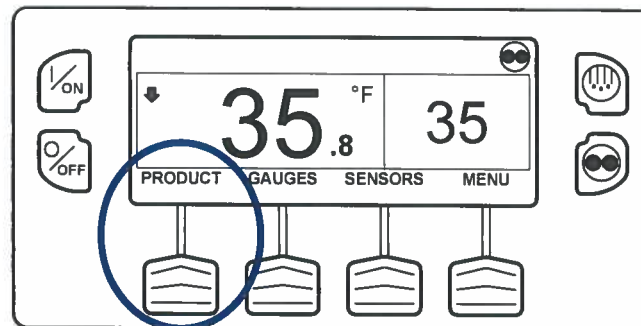



## Section 4 – SR-4 Trailer S/T Electronic Engine Operation

---

### Changing the Setpoint – (continued)

#### Both Numerical Setpoints and Named Products

OptiSet Plus can allow the use of both Numerical Setpoints and Named Products. If both numerical setpoints and named products are enabled the left soft key will be labeled PRODUCT/SETPOINT as shown below.

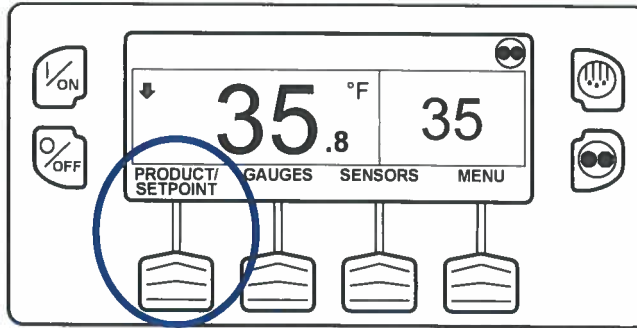

## Section 4 – SR-4 Trailer S/T Electronic Engine Operation

---

### Changing the Setpoint – (continued)

#### Changing the Setpoint – Numerical Setpoint

If the Temperature Watch display is shown, press any soft key to return to the Standard Display. From the Standard Display, press the SETPOINT Key.

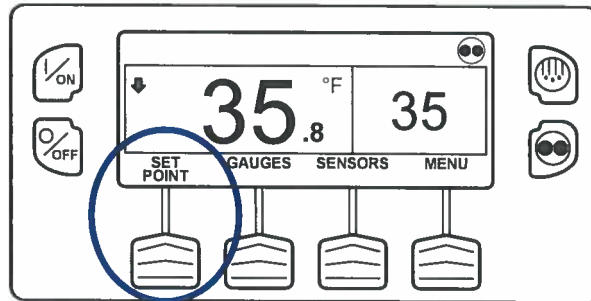

The setpoint display appears as shown below.

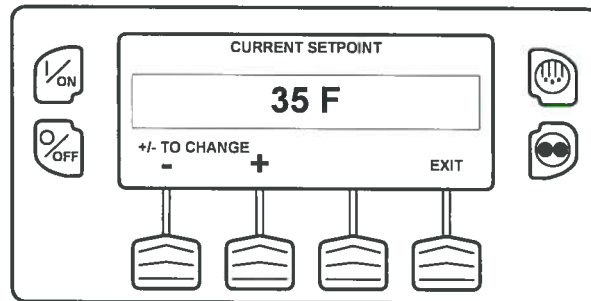

The "-" and "+" Keys are used to increase or decrease the setpoint until the desired setpoint is shown. Here the setpoint has been changed to 40°F using the "+" Key.

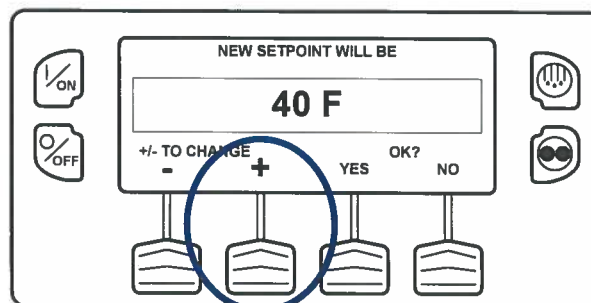

## Section 4 – SR-4 Trailer S/T Electronic Engine Operation

---

### Changing the Setpoint – (continued)

The YES and NO Keys confirm the setpoint change. When the desired setpoint has been selected using the "+" and/or "-" Keys, press the YES Key to confirm and load the new setpoint. If the setpoint is changed using the "+" or "-" Keys, the change must be confirmed or rejected by pressing the YES or NO Key within 10 seconds of changing the setpoint. A warning beep will sound for 5 seconds as a reminder.

Failure to confirm the new setpoint by pressing Yes or No within 10 seconds of changing the setpoint will result in no setpoint change. In addition, Alarm Code 127 Setpoint Not Entered is set, to indicate that a setpoint change was initiated but not completed.

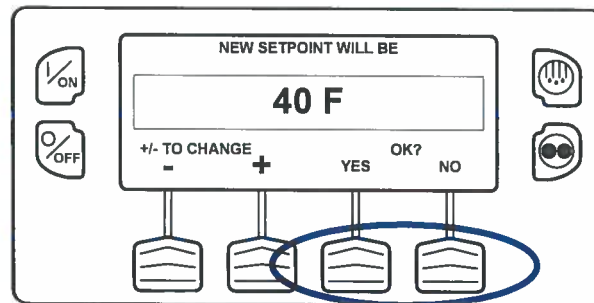

After the YES Key has been pressed, the display briefly shows PROGRAMMING NEW SETPOINT – PLEASE WAIT. The display then confirms the new setpoint for several seconds.

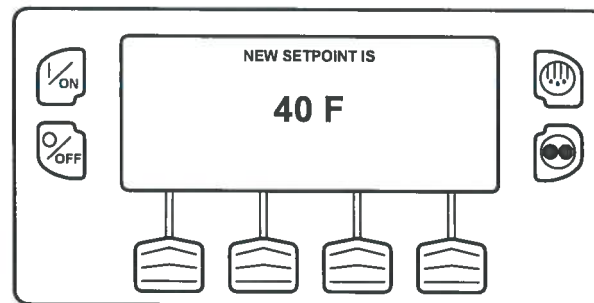

If the NO Key is pressed the display will briefly show SETPOINT NOT CHANGED and return to the Standard Display. The Standard Display will show the old setpoint.

## Section 4 – SR-4 Trailer S/T Electronic Engine Operation

---

### Changing the Setpoint – (continued)

The display then returns to the Standard Display showing the new setpoint. Notice that the arrow now points up, to indicate that the unit is heating.

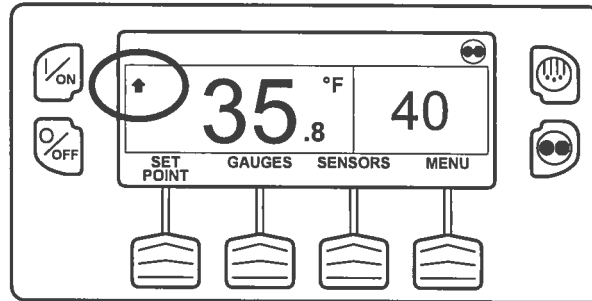

**IMPORTANT:** If the setpoint is changed using the "+" or "-" Keys, the change must be confirmed or rejected by pressing the YES or NO Key within 10 seconds of changing the setpoint.

- If the YES Key is pressed, the setpoint change made with the "+" or "-" Key is accepted, the setpoint changes, and the display returns to the Standard Display.
- If the NO Key is pressed the setpoint change made with the "+" or "-" Key is not accepted, the setpoint is not changed, and the display returns to the Standard Display.
- If the YES or NO Key is not pressed within 10 seconds of making a change with the "+" or "-" Key, the setpoint is is not changed and the display returns to the Standard Display. The display briefly shows [SETPOINT NOT CHANGED] and **Alarm Code 127 Setpoint Not Entered** is set, to indicate that a setpoint change was initiated but not completed.

## Section 4 – SR-4 Trailer S/T Electronic Engine Operation

---

### INITIATING A MANUAL DEFROST CYCLE

Defrost cycles are usually initiated automatically based on time or demand. Manual defrost is also available

Manual defrost is available if the unit is running and the evaporator coil temperature is less than or equal to 45°F (7°C).

**NOTE: If the Rail Alternate feature is set YES defrost is allowed with an evaporator coil temperature less than or equal to 55°F (13°C).**

Other features such as door switch settings may not allow manual defrost under some conditions. To initiate a manual defrost cycle, press the Defrost Key as shown below.

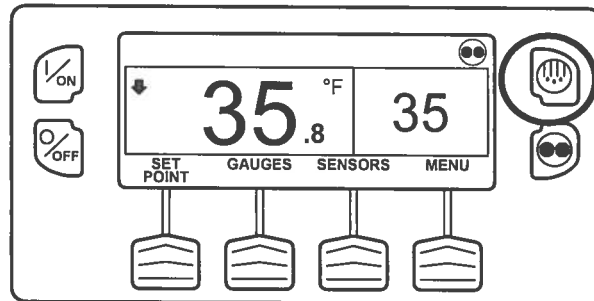

The display briefly shows [DEFROST], [PROGRAMMING DEFROST - PLEASE WAIT] and then [DEFROST STARTED].

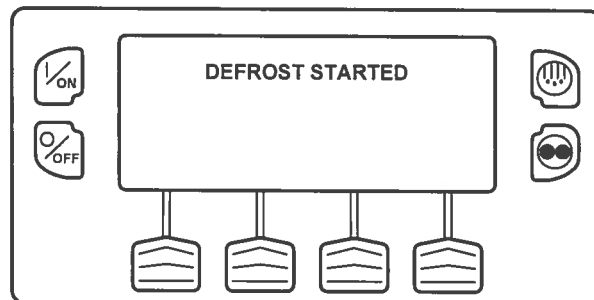

## Section 4 – SR-4 Trailer S/T Electronic Engine Operation

---

### Initiating a Manual Defrost Cycle - continued

The display then shows the Defrost display. The bar indicator shows approximately how much time remains to complete the defrost cycle. The bar indicator below shows that the defrost cycle is about 25% complete.

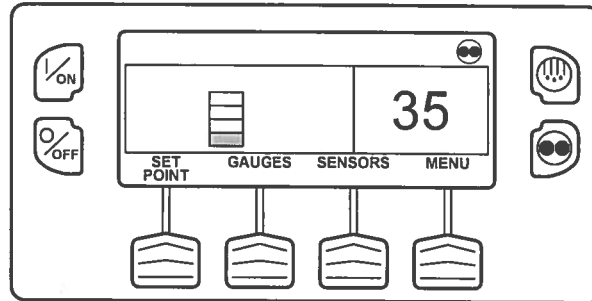

If conditions do not allow a defrost cycle, the display shown below will briefly appear. The display will then return to the Standard Display.

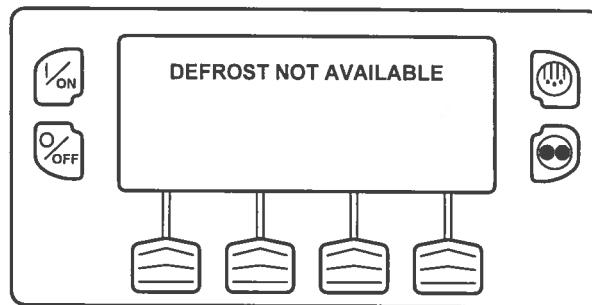

### Terminating a Defrost Cycle

The defrost cycle terminates automatically when the coil temperature is greater than or equal to 58°F (14°C) or the defrost timer expires. Defrost can also be terminated by turning the unit off and back on.

**NOTE:** If Rail Alternate is set YES the defrost cycle terminates at 70°F (21°C) or if the defrost timer expires.

## Section 4 – SR-4 Trailer S/T Electronic Engine Operation

---

### SELECTING CYCLE SENTRY OR CONTINUOUS MODE

When Cycle Sentry Mode is selected the unit will start and stop automatically to maintain setpoint, keep the engine warm and the battery charged. When Continuous Mode is selected, the unit starts automatically and runs continuously to maintain setpoint and provide constant airflow.

**IMPORTANT:** Cycle Sentry or Continuous Mode may not be selectable if OptiSet Plus is in use.

If the unit is operating in Cycle Sentry Mode, the Cycle Sentry Icon will be present in the upper right corner of the display as shown below. If the Cycle Sentry Icon is not present the unit is operating in Continuous Mode.

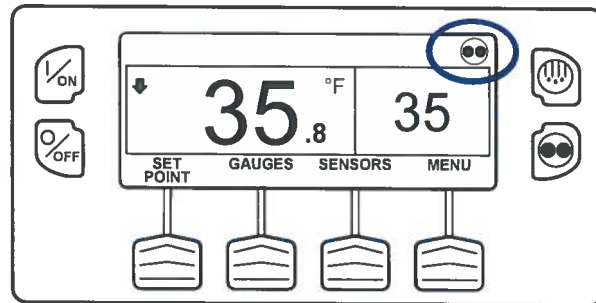

If allowed by OptiSet Plus, Cycle Sentry Mode or Continuous Mode is selected by pressing the Cycle Sentry/Continuous Key as shown below.

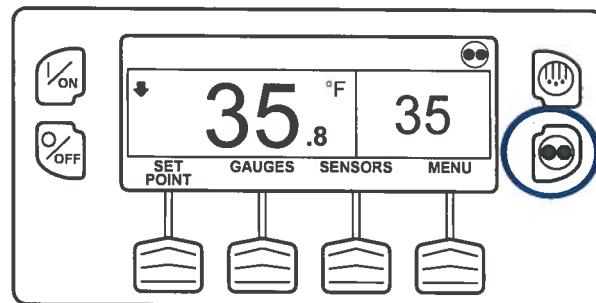

**NOTE:** Cycle Sentry Mode or Continuous Mode can also be selected using the Main Menu > Mode Submenu.

## Section 4 – SR-4 Trailer S/T Electronic Engine Operation

---

### Selecting Cycle Sentry or Continuous Mode - (continued)

If the unit is in Cycle Sentry Mode, pressing the Cycle Sentry/Continuous Key changes the mode from Cycle Sentry Mode to Continuous Mode. The display confirms the change, as shown below.

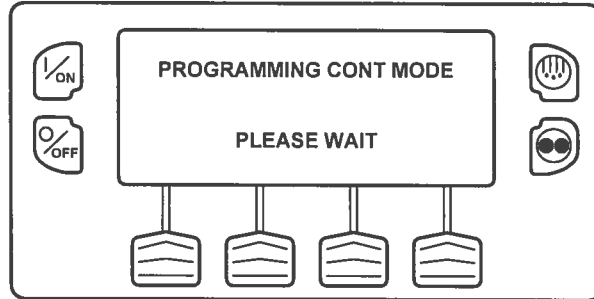

The new mode is confirmed for 3 seconds.

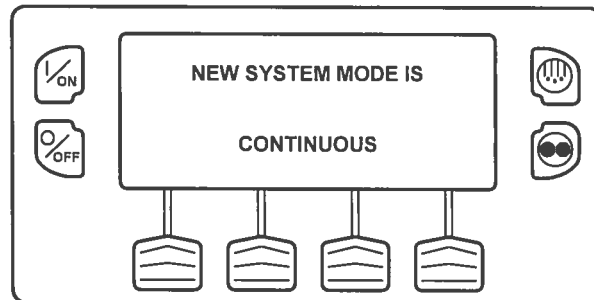

The display then returns to the Standard Display. In the example shown below the absence of the Cycle Sentry Icon indicates that the unit is running in Continuous Mode.

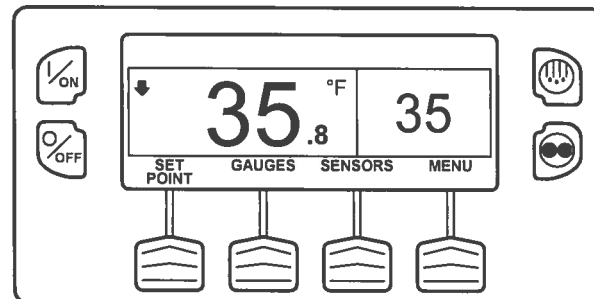



## Section 4 – SR-4 Trailer S/T Electronic Engine Operation

---

### Selecting Cycle Sentry or Continuous Mode - (continued)

Pressing the Cycle Sentry/Continuous Key again allows the operator to change back to Cycle Sentry Mode operation.

**IMPORTANT:** If the unit is in Cycle Sentry Null and the mode is switched to Continuous Mode, the unit will start automatically.

**IMPORTANT:** Cycle Sentry or Continuous Mode may not be selectable if OptiSet Plus is in use.